

USER MANUAL



**S100 SART**

**Search and Rescue  
Transponder**

English

[www.oceansignal.com](http://www.oceansignal.com)



Copyright © 2024 by Ocean Signal Ltd.

All contents of this manual are the intellectual property of Ocean Signal Ltd.

This includes but is not limited to text, diagrams, illustrations, and any other materials contained herein. No part of this manual may be altered and further produced in any form, electronic or mechanical, without the prior written permission of Ocean Signal Ltd.

For permission requests or inquiries, please contact [help@oceansignal.com](mailto:help@oceansignal.com)

Ocean Signal Ltd. reserves the right to change or update the contents of this manual without prior notice. While every effort has been made to ensure the accuracy of the information provided, Ocean Signal Ltd. assumes no responsibility for errors or omissions.

Ocean Signal® and safeSEA® are registered trademarks of Ocean Signal Ltd



## IN CASE OF EMERGENCY



1 Press release latch and remove from bracket.

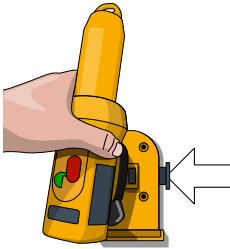

2 Break off clear protective cover over the the green and red switches.



3 Holding the green switch to the left, push the red switch down and hold.

**NOTE:**  
this will  
activate  
SART

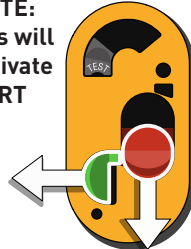

4 Whilst holding the red switch down, release the green switch to lock in active position.

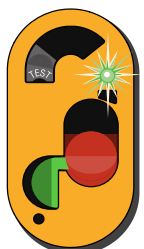

5 Use the lanyard to attach the S100 SART to the roof of the liferaft.

**NOTE:** Thread the lanyard through the lanyard attachment point before tying to the liferaft canopy in order to maintain an upright position.

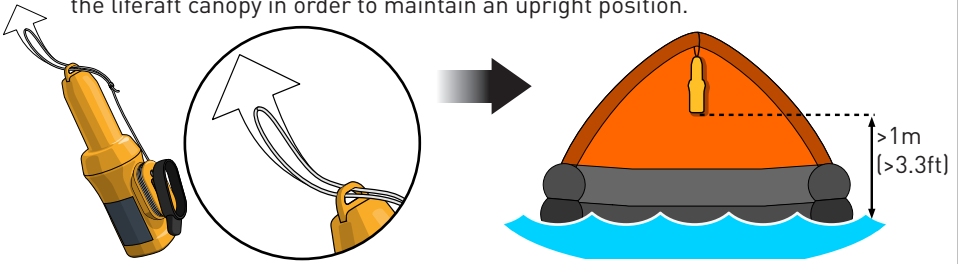

The S100 SART should be mounted at least 1m (3.3ft) above sea level for maximum effectiveness during activation.



The S100 SART should be tethered to the life raft using the lanyard to avoid being lost overboard.

**NOTE:** Refer to section 4.3 for deployment instructions.

**NOTE:** Refer to section 4.4 for deactivation instructions.

## Contents

<b>1.</b>	<b>GENERALITES</b>	<b>5</b>
1.1	Exposition aux rayonnements électromagnétiques	5
1.2	Important	5
1.3	Contenu du S100 SART	5
<b>2.</b>	<b>S100 – VUE GENERALE</b>	<b>6</b>
<b>3.</b>	<b>INSTALLATION</b>	<b>7</b>
3.1	Installation du Support	7
3.2	Installation de la batterie	8
<b>4.</b>	<b>UTILISATION</b>	<b>8</b>
4.1	Activation	8
4.2	Indications optiques lors de l'activation	9
4.3	Déploiement	9
4.4	Désactivation	10
<b>5.</b>	<b>TEST</b>	<b>10</b>
5.1	Test de fonctionnalité	10
<b>6.</b>	<b>BATTERIES</b>	<b>11</b>
6.1	Remplacement de la pile	12
<b>7.</b>	<b>ANNEXES</b>	<b>13</b>
7.1	Entretien et dépannage	13
7.2	Informations sur la sécurité de la batterie	13
7.3	Manipulation et stockage	13
7.4	Transportation	14
7.5	Accessoires	14
7.6	Specifications	14
7.7	Approvals	15
7.8	Limitation de garantie	15

## 1. GENERAL

### 1.1 Exposure to RF Electromagnetic Energy

This product has been evaluated for compliance with the FCC RF exposure limits given in CFR 47 part 2.1093: Portable Devices

### 1.2 Warnings

- Always operate the S100 SART with any part of the device at least 6cm (2.4in) away from your body
- The S100 SART is designed for use in emergency only. Only operate it in situations of grave and imminent danger.
- The S100 SART incorporates a protective tab over the operating controls to avoid accidental activation and indicate that the unit has been used.
- After any period of operation, the battery should be replaced and the unit returned to your local service dealer for replacement of the protective tab.
- Always replace the battery before the expiry date is exceeded to ensure full operating capacity in case of emergency.
- Please ensure you follow local regulations before disposing of this item. Ensure the battery is removed from the unit before disposal.

### 1.3 S100 SART Contents

1	4x Screws (for Bracket)
2	S100 SART
3	Quick Start Guide
4	Hex Key (for battery)
5	LB3S Battery Module
6	Mounting Bracket

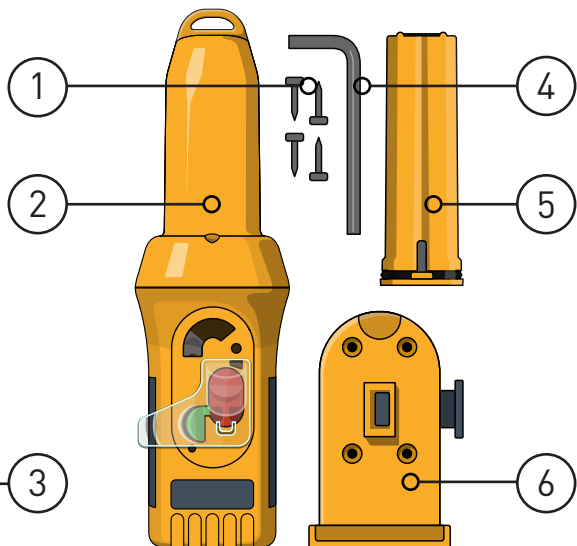

## 2. S100 SART OVERVIEW

1. Lanyard Attachment Point
2. Test Switch
3. Activation Switch
4. Clear Protective Cover
5. Indicator LED
6. Interlock Switch
7. Attachment Point for Optional Pole
8. Battery Module with Expiry Date

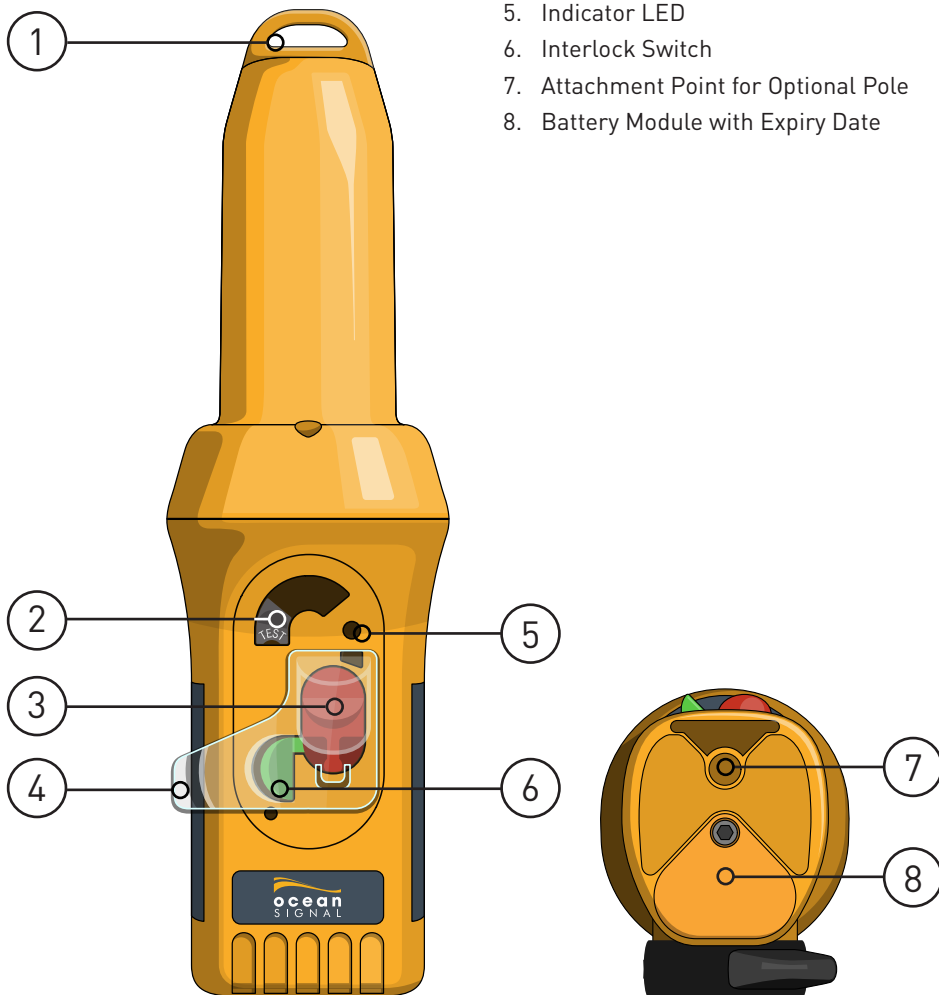

## 3. INSTALLATION

### 3.1 Bracket Installation

The S100 SART is supplied with a quick release mounting bracket. This bracket should be mounted on a suitable wall or bulkhead in a position where it can easily be retrieved in an emergency.

Although the S100 SART is rugged and waterproof, Ocean Signal recommends mounting the unit in a protected position whenever possible.

 **Do not mount the S100 SART closer than 1 meter to any steering compass as this may affect the accuracy of the compass.**

 **Keep the S100 SART away from any strong magnetic sources such as loudspeakers, compass compensation magnets, etc.**

Mark the location of the four screw holes onto the mounting position. Pre-drill the holes if required then screw the mounting bracket to the surface using the four No6 x 5/8" screws supplied.

The S100 SART simply clips onto the mounting bracket.

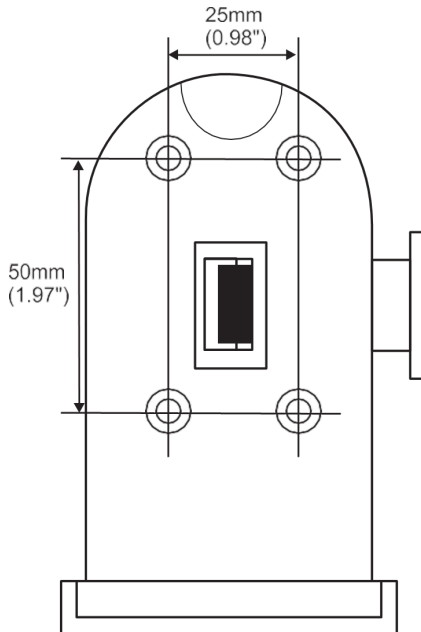

## 3.2 Battery Installation

The battery pack is retained by a single hex head screw using the 3mm hex key provided.

Insert the battery pack into the bottom of the S100 SART, ensuring that the rubber seal is correctly in position.

Tighten the screw until the battery is fully home within the S100 SART body, torque not exceeding 0.5Nm.

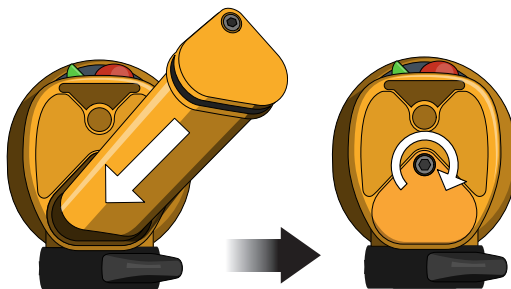

## 4. OPERATION

Ensure the S100 SART is fitted with an unused battery that is within the marked expiry date.

**⚠ A SART is not intended as a primary distress alerting device. At least one of the following should also be carried on-board your vessel to alert the authorities to your situation: an EPIRB; a DSC radio; an Inmarsat satellite terminal.**

Once the S100 SART is activated it will help guide the Search and Rescue authorities to your position.

### 4.1 Activation

**⚠ The S100 SART should only be activated if there is grave and imminent danger to the vessel and its crew.**

To activate the S100 SART, remove the unit from its mounting bracket.

Break off the clear protective cover over the green and red switches.

Holding the green switch to the left, push the red switch down and hold.

While holding the red switch down, release the green switch to lock the red switch in the active position.

**NOTE: See section 4.2 for optical indications on activation**

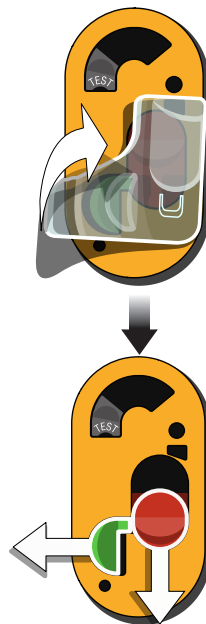



## 4.2 Optical Indications on Activation

During operation, the red LED next to the Test switch will flash once every 2-3 seconds to indicate the SART is operational:



When activated by a received radar pulse the red LED will start flashing rapidly:



## 4.3 Deployment



**The lanyard should be unwound and tied securely to the life raft to ensure the S100 SART is not lost overboard.**

For the best performance, it is important that the S100 SART is mounted as high as possible in the life raft.

Remove the rubber lanyard cover from the back of the S100 SART to reveal the lanyard stowed underneath. Use this lanyard to attach the S100 SART directly to the liferaft canopy or tie the lanyard around the inflatable tube supporting the canopy.

**NOTE: Thread the lanyard through the attachment point at the top of the SART. This will allow the SART to remain in an upright position when attached to the liferaft canopy from above.**

The S100 SART can be fitted with the optional telescopic pole which will keep the unit at a height of 1 meter (3.3 ft) above sea level.

See the instructions supplied with the optional telescopic pole for correct attachment and use.

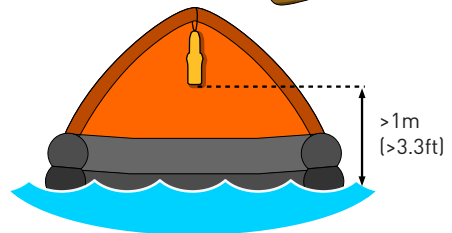
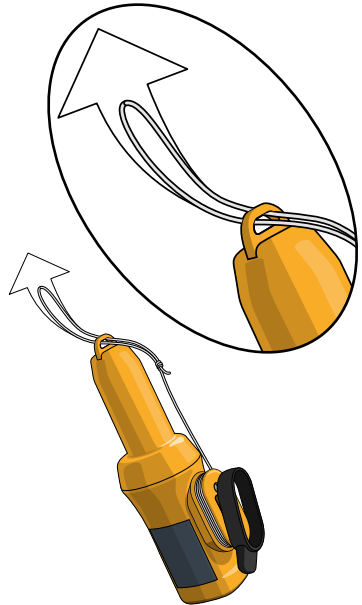

## 4.4 Désactivation

If the S100 SART has been inadvertently activated, it can be turned off simply by reversing the activation process.

Holding the green switch to the left, push the red switch upwards to return to the off position.

Release the green switch.



**It is not possible for the user to replace the clear protective cover. Return the S100 SART to an Ocean Signal authorised service centre for replacement.**

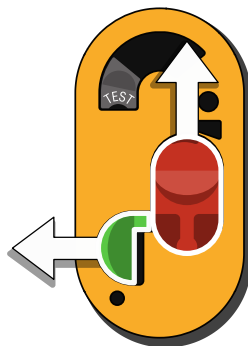

## 5. TESTING

### 5.1 Function test



**This test should be carried out once per year.**

It is recommended that the S100 SART is tested once a year in conjunction with an X-band radar on a nearby vessel if possible. A full test should always be carried out as part of the annual service, with short inspections every two months.

Activate Test Mode by rotating the grey test switch clockwise and holding.

If there is radar activity in the area then the red LED will start to flash intermittently, indicating that the radar signals are being received.

The radar display of any vessels within radar detection range of your location will now be showing the return from the S100 SART.



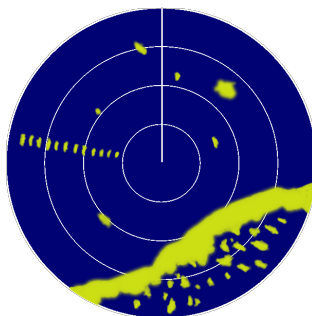



Depending on the distance of the vessel to the S100 SART and the tuning of the radar, the display will vary between a set of concentric rings to a line of twelve blips in a straight line on a bearing between the vessel and the S100 SART.



**Test Mode is the same as Activation Mode, so keep the test duration to a minimum to avoid falsely alerting other vessels that you may be in distress and minimise battery drain**

## 6. BATTERIES

The S100 SART uses a Lithium Iron Disulfide battery pack to power the device. These batteries have a five year storage life before any significant reduction in capacity. Each battery is marked with an expiry date, which is located at the base of the unit.

-  **The battery should be replaced before the expiry date has passed to ensure reliable operation and full capacity in emergency situations.**
-  **Always use batteries manufactured by Ocean Signal. Failure to do so will invalidate the type approval and may mean the unit does not operate correctly in a distress situation.**
-  **Never dispose of batteries in a fire.**
-  **Never puncture or attempt to dismantle the battery.**
-  **Never attempt to charge the battery.**
-  **Extreme temperature caused by failure to observe the above warnings may cause the battery to explode or catch fire, which may result in injury or damage to surrounding personnel or property.**
-  **Dispose of used batteries in a responsible manner. National or local regulations on battery disposal may apply including restricting the disposal of batteries in domestic refuse.**

For the Product Safety Data Sheet and advice on battery transportation, please see the Ocean Signal website at [www.oceansignal.com](http://www.oceansignal.com).

## 6.1 Battery Replacement

The battery may be changed by the user, although commercial vessels may be subject to local regulations relating to Shore Based Maintenance that prevent this.

Remove the S100 SART from its mounting bracket and turn it over. The battery pack is retained by a single hex head screw. Undo the screw using the 3mm hex key provided.

Remove the pack from the main body.

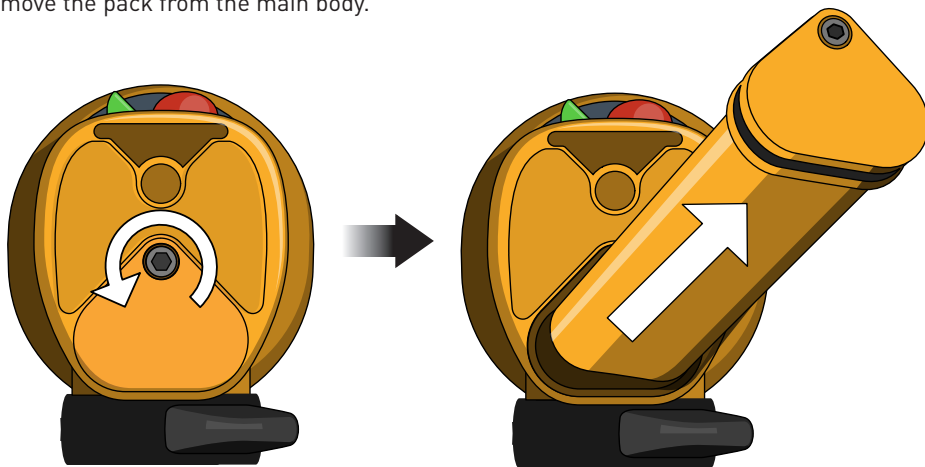

Insert new battery pack, ensuring that the rubber seal is correctly in position.

 **Tighten the screw until the battery is fully home within the S100 SART body, torque not exceeding 0.5Nm.**

 **Ensure that any maintenance records on-board are updated with the new battery expiry date.**



## 7. APPENDIX

### 7.1 Maintenance and Troubleshooting

The S100 SART should not need servicing during its lifetime, with the exception of changing the battery before the marked expiry date.

Regular cleaning, inspection and testing are advised - clean any grime or salt residue off the unit with a weak solution of detergent in warm water. Never use solvents as this may affect the structural integrity of the plastics used. Rinse well with fresh water after cleaning.

Inspect the unit for signs of case damage or cracks, check the labels are intact and the battery is within the expiry date. Make sure the optional telescopic pole (if provided) is still present and is free to extend.

Check for correct SART operation using the Test Mode (section 5). If the S100 SART appears to fail testing, contact a service representative at Ocean Signal.

### 7.2 Battery Safety Information

Manufacturer name: LB3S  
Volts: 3.0V nominal  
Approximate weight: 89grams  
Chemical system:  $\text{LiFeS}_2$   
Lithium weight/cell: 0.98g  
Total lithium weight/battery: 1.96g  
Designated for recharge: No

For information regarding the physical and chemical properties, the potential health and safety measures and the environmental effects of the battery used with this product, refer to the manufacturer's safety information documentation.

The safety information is available for download at [www.oceansignal.com](http://www.oceansignal.com).

### 7.3 Handling and Storage

This product should be stored in a cool and well-ventilated area. Elevated temperatures can result in a reduction of battery life. Locations that handle large quantities of lithium batteries must ensure the batteries are isolated from combustibles.

Avoid accidentally short-circuiting batteries. Prolonged short-circuiting can cause the battery temperature to rise and significantly reduce battery life.

## 7.4 Transportation

The (LB3S) SART battery module has been tested in accordance with subsection 38.3 of part III of the UN Manual of Tests and Criteria. Summary test reports are available from Ocean Signal on request.

This battery module should be transported by air in accordance with the IATA dangerous goods regulations: class 9, UN3090, proper name “Lithium metal batteries” and packed according to packing instruction 968 section Ib.

When supplied with equipment it is class 9, UN3091, proper name “Lithium metal batteries packed with equipment” and should be packed in accordance with packing instruction 969 section II.

## 7.5 Accessoires

Replacement LB3S SART Lithium Battery ..... Part No.: 711S-00609  
Optional Telescopic Mounting Pole ..... Part No.: 711S-01802

## 7.6 Specifications

### Transmitter

Frequency ..... 9.2-9.5GHz  
Output Power (EIRP) ..... >400mW  
Number of sweeps per interrogation ..... 12

### Battery

Type ..... Disulfure de fer et de lithium (LiFeS2)  
Operating life (standby/active) ..... 96/12 heures à -20°C  
Lithium Metal Weight (for air transport) ..... <2g par batterie  
Replacement Interval ..... 5 ans

### Test Standards

Standards ..... IEC61097-1, IEC60945

### Environmental

IEC60945 Category ..... Portable  
Temperature Range (operating) ..... -20°C to +55°C  
Temperature Range (storage) ..... -30°C to +65°C  
Waterproof ..... 10 metres  
Drop Proof (on water) ..... 20 metres  
Compass Safe Distance ..... 1 metre



## 7.7 Approvals

The S100 SART is approved under the EU Marine Equipment Directive under MED/4.18 of the current implementing regulation. The Declaration of Conformity can be downloaded from [www.oceansignal.com](http://www.oceansignal.com).

The S100 SART is approved under the UK Marine Equipment Regulations, MSN 1874 as amended.

The S100 SART complies with the GMDSS provisions of part 80 of the FCC rules.

## 7.8 Limited Warranty

Your S100 SART is warranted against manufacturing defects in materials and workmanship for a period of two years from date of purchase. Ocean Signal will, at its discretion, repair or replace a faulty product free of charge, including return carriage costs to the owner.

For further assistance, please contact our Technical Service Department:

Email: [help@oceansignal.com](mailto:help@oceansignal.com)

Accidental damage and misuse or non-approved modifications are not covered by this warranty. This warranty does not affect your statutory rights.

See <https://oceansignal.com/products/s100-sart/> for further warranty information.

Dealer Stamp:

Date of Purchase:

Ocean Signal Ltd.  
Unit 4, Ocivan Way  
Margate  
CT9 4NN  
United Kingdom

[help@oceansignal.com](mailto:help@oceansignal.com)

[www.oceansignal.com](http://www.oceansignal.com)

